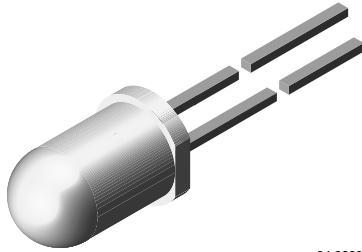


## High Power Infrared Emitting Diode, 940 nm, GaAlAs/GaAs



94 8389

### DESCRIPTION

TSAL7300 is an infrared, 940 nm emitting diode in GaAlAs/GaAs technology with high radiant power molded in a clear, untinted plastic package.

### FEATURES

- Package type: leaded
- Package form: T-1 $\frac{3}{4}$
- Dimensions (in mm):  $\varnothing$  5
- Peak wavelength:  $\lambda_p = 940$  nm
- High reliability
- High radiant power
- High radiant intensity
- Angle of half intensity:  $\varphi = \pm 22^\circ$
- Low forward voltage
- Suitable for high pulse current operation
- Good spectral matching with Si photodetectors
- Compliant to RoHS directive 2002/95/EC and in accordance to WEEE 2002/96/EC
- Halogen-free according to IEC 61249-2-21 definition



**RoHS**  
COMPLIANT  
HALOGEN  
**FREE**

### APPLICATIONS

- Infrared remote control units with high power requirements
- Free air transmission systems
- Infrared source for optical counters and card readers

### PRODUCT SUMMARY

COMPONENT	$I_e$ (mW/sr)	$\varphi$ (deg)	$\lambda_p$ (nm)	$t_r$ (ns)
TSAL7300	45	$\pm 22$	940	800

#### Note

Test conditions see table "Basic Characteristics"

### ORDERING INFORMATION

ORDERING CODE	PACKAGING	REMARKS	PACKAGE FORM
TSAL7300	Bulk	MOQ: 4000 pcs, 4000 pcs/bulk	T-1 $\frac{3}{4}$

#### Note

MOQ: minimum order quantity

### ABSOLUTE MAXIMUM RATINGS

PARAMETER	TEST CONDITION	SYMBOL	VALUE	UNIT
Reverse voltage		$V_R$	5	V
Forward current		$I_F$	100	mA
Peak forward current	$t_p/T = 0.5, t_p = 100 \mu s$	$I_{FM}$	200	mA
Surge forward current	$t_p = 100 \mu s$	$I_{FSM}$	1.5	A
Power dissipation		$P_V$	160	mW
Junction temperature		$T_j$	100	$^\circ C$
Operating temperature range		$T_{amb}$	- 40 to + 85	$^\circ C$
Storage temperature range		$T_{stg}$	- 40 to + 100	$^\circ C$
Soldering temperature	$t \leq 5$ s, 2 mm from case	$T_{sd}$	260	$^\circ C$
Thermal resistance junction/ambient	J-STD-051, leads 7 mm soldered on PCB	$R_{thJA}$	230	K/W

#### Note

$T_{amb} = 25 \text{ }^\circ C$ , unless otherwise specified

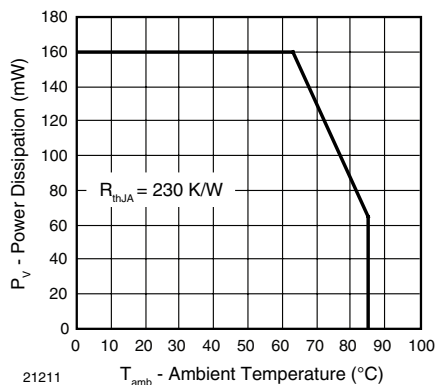


Fig. 1 - Power Dissipation Limit vs. Ambient Temperature

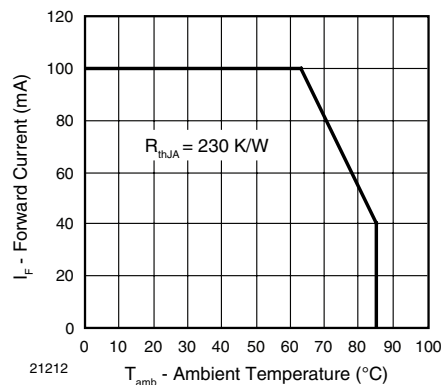


Fig. 2 - Forward Current Limit vs. Ambient Temperature

BASIC CHARACTERISTICS						
PARAMETER	TEST CONDITION	SYMBOL	MIN.	TYP.	MAX.	UNIT
Forward voltage	$I_F = 100 \text{ mA}, t_p = 20 \text{ ms}$	$V_F$		1.35	1.6	V
	$I_F = 1 \text{ A}, t_p = 100 \mu\text{s}$	$V_F$		2.6	3	V
Temperature coefficient of $V_F$	$I_F = 1 \text{ mA}$	$TK_{V_F}$		- 1.8		mV/K
Reverse current	$V_R = 5 \text{ V}$	$I_R$			10	$\mu\text{A}$
Junction capacitance	$V_R = 0 \text{ V}, f = 1 \text{ MHz}, E = 0$	$C_j$		25		pF
Radiant intensity	$I_F = 100 \text{ mA}, t_p = 20 \text{ ms}$	$I_e$	30	45	150	mW/sr
	$I_F = 1 \text{ A}, t_p = 100 \mu\text{s}$	$I_e$	260	350		mW/sr
Radiant power	$I_F = 100 \text{ mA}, t_p = 20 \text{ ms}$	$\phi_e$		35		mW
Temperature coefficient of $\phi_e$	$I_F = 20 \text{ mA}$	$TK_{\phi_e}$		- 0.6		%/K
Angle of half intensity		$\phi$		$\pm 22$		deg
Peak wavelength	$I_F = 100 \text{ mA}$	$\lambda_p$		940		nm
Spectral bandwidth	$I_F = 100 \text{ mA}$	$\Delta\lambda$		50		nm
Temperature coefficient of $\lambda_p$	$I_F = 100 \text{ mA}$	$TK_{\lambda_p}$		0.2		nm/K
Rise time	$I_F = 100 \text{ mA}$	$t_r$		800		ns
	$I_F = 1 \text{ A}$	$t_r$		500		ns
Fall time	$I_F = 100 \text{ mA}$	$t_f$		800		ns
	$I_F = 1 \text{ A}$	$t_f$		500		ns
Virtual source diameter	Method: 63 % encircled energy	d		2.3		mm

**Note**

$T_{amb} = 25 \text{ }^\circ\text{C}$ , unless otherwise specified

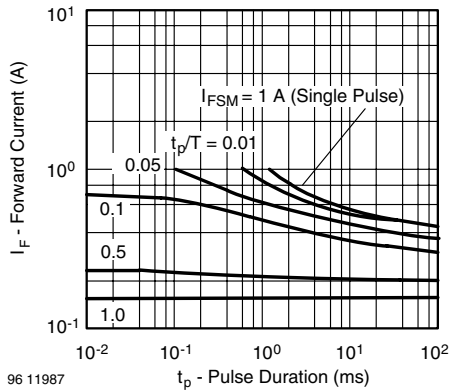
**BASIC CHARACTERISTICS**
 $T_{amb} = 25\text{ }^{\circ}\text{C}$ , unless otherwise specified


Fig. 3 - Pulse Forward Current vs. Pulse Duration

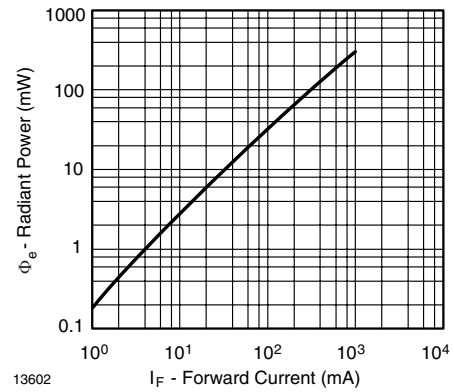


Fig. 6 - Radiant Power vs. Forward Current

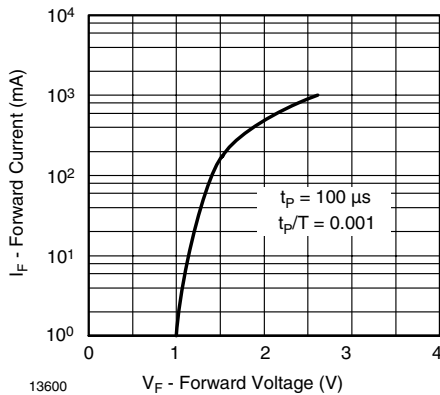


Fig. 4 - Forward Current vs. Forward Voltage

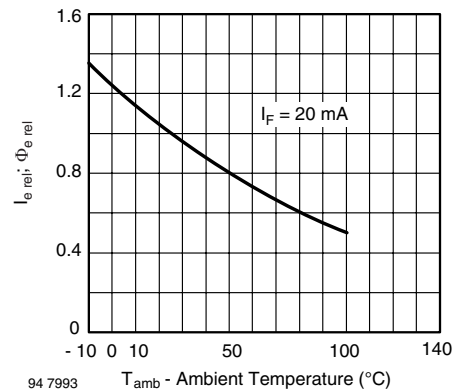


Fig. 7 - Relative Radiant Intensity/Power vs. Ambient Temperature

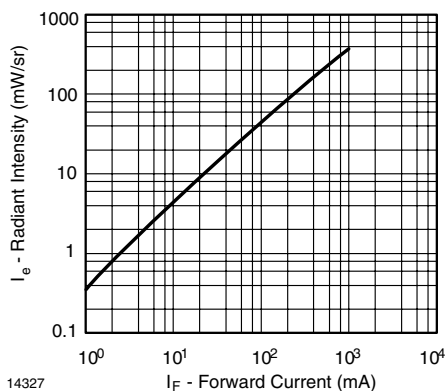


Fig. 5 - Radiant Intensity vs. Forward Current

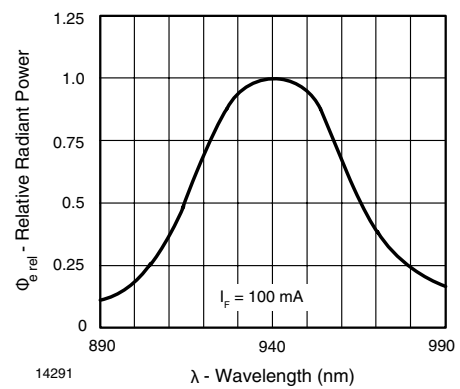


Fig. 8 - Relative Radiant Power vs. Wavelength

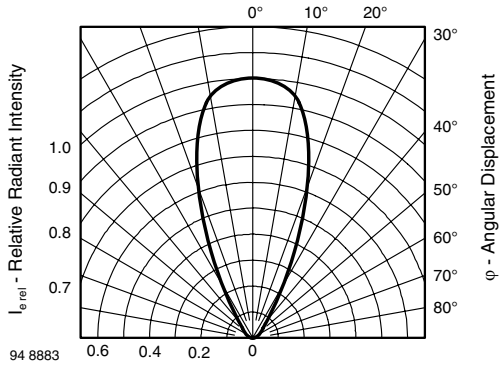
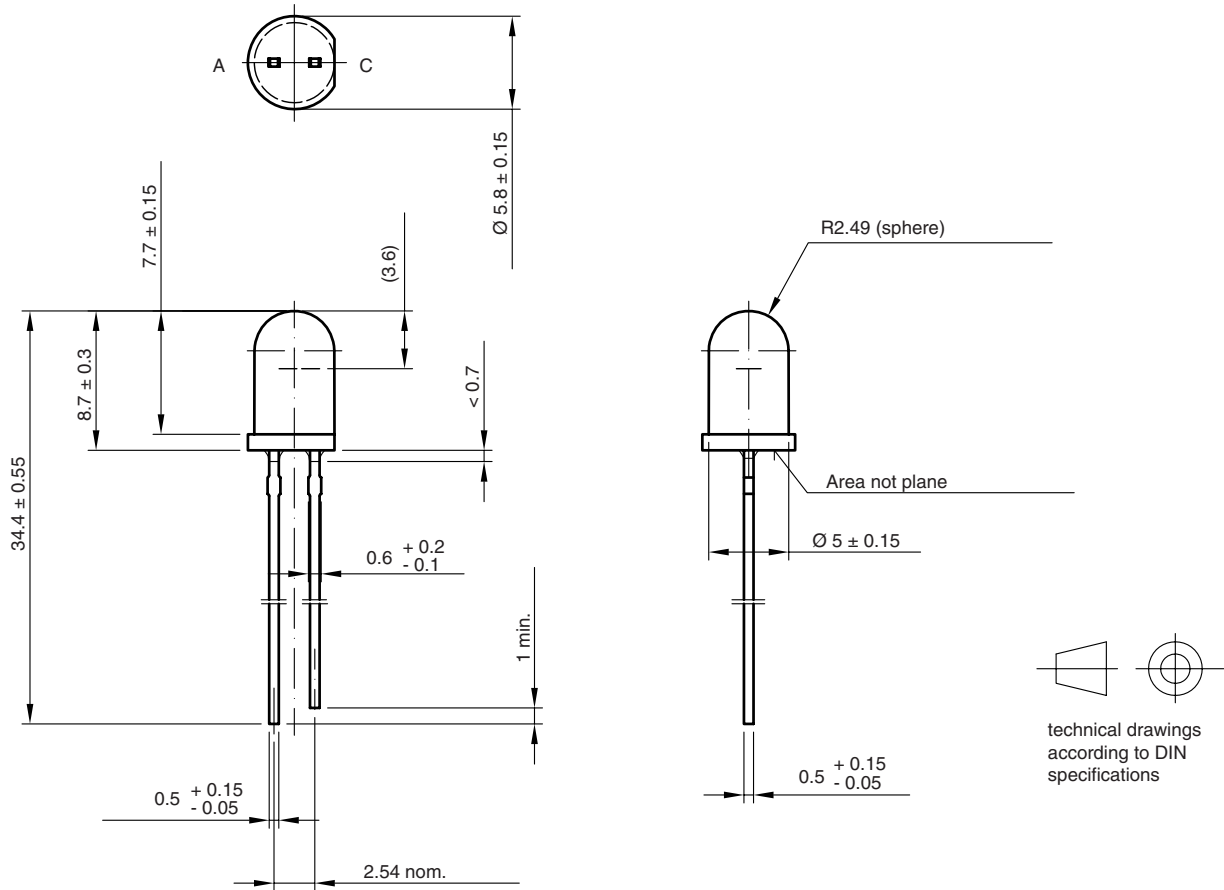


Fig. 9 - Relative Radiant Intensity vs. Angular Displacement

## PACKAGE DIMENSIONS in millimeters



6.544-5259.05-4  
Issue: 8; 19.05.09  
96 12126



## Disclaimer

All product specifications and data are subject to change without notice.

Vishay Intertechnology, Inc., its affiliates, agents, and employees, and all persons acting on its or their behalf (collectively, "Vishay"), disclaim any and all liability for any errors, inaccuracies or incompleteness contained herein or in any other disclosure relating to any product.

Vishay disclaims any and all liability arising out of the use or application of any product described herein or of any information provided herein to the maximum extent permitted by law. The product specifications do not expand or otherwise modify Vishay's terms and conditions of purchase, including but not limited to the warranty expressed therein, which apply to these products.

No license, express or implied, by estoppel or otherwise, to any intellectual property rights is granted by this document or by any conduct of Vishay.

The products shown herein are not designed for use in medical, life-saving, or life-sustaining applications unless otherwise expressly indicated. Customers using or selling Vishay products not expressly indicated for use in such applications do so entirely at their own risk and agree to fully indemnify Vishay for any damages arising or resulting from such use or sale. Please contact authorized Vishay personnel to obtain written terms and conditions regarding products designed for such applications.

Product names and markings noted herein may be trademarks of their respective owners.